

## INSTRUCTION MANUAL

"Intelligent" Pressure and level transmitters

## SERIES 4000

## SERIES 4000-SAN



**HART**  
COMMUNICATION PROTOCOL

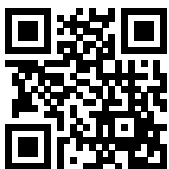

• Warning •

Read the recommendations and warnings in this manual before the instrument is installed. For personal safety, optimal use and maintenance of the Series 4000 and 4000 SAN, these instructions must be studied carefully.

*Manufactured by:*

 **KLAY-INSTRUMENTS B.V.**

[www.klay.nl](http://www.klay.nl)

Nijverheidsweg 5  
P.O. Box 13  
Tel: +31-521-591550  
Fax: +31 -521-592046

7991 CZ DWINGELOO  
7990 AA DWINGELOO  
The Netherlands  
E-mail: [info@klay.nl](mailto:info@klay.nl)

## TABLE OF CONTENTS

<b>1. INTRODUCTION.....</b>	<b>3</b>
1.1 DESCRIPTION SERIES 4000-SAN .....	3
1.2 DESCRIPTION SERIES 4000.....	3
1.3 BAROMETRIC REFERENCE .....	3
<b>2. DIMENSIONAL DRAWINGS .....</b>	<b>4</b>
<b>3. INSTALLING THE TRANSMITTER .....</b>	<b>5</b>
3.1 INSTALLING WELD-ON NIPPLE.....	5
3.2 INSTALLING TRANSMITTER SERIES 4000-SAN (Code W) .....	5
3.3 INSTALLING TRANSMITTER SERIES 4000 (Code W33).....	5
3.4 MOUNTING POSITION.....	6
3.5 MOUNTING POSITION EFFECT .....	6
3.6 CALIBRATION .....	6
3.7 WIRING.....	6
<b>4. REMAINING .....</b>	<b>7</b>
4.1 EXTERNAL LOAD .....	7
4.2 CE/EMC-RULES.....	7
4.3 TRACEABILITY / YEAR OF MANUFACTURING .....	7
4.4 INTRINSICALLY SAFE (Option Ex) .....	8
<b>5. GRAPHIC DISPLAY AND NAVIGATION BUTTON .....</b>	<b>9</b>
5.2 SUMMARY PROGRAMMING POINTS .....	10
<b>6. EXPLANATION PROGRAMMING POINTS .....</b>	<b>11</b>
6.1 ZERO ADJUSTMENT (ZERO, 4 mA) .....	11
6.2 SPAN ADJUSTMENT (SPAN, 20 mA) .....	11
6.3 CANCEL MOUNTING POSITION EFFECT (4 mA).....	12
6.4 DISPLAY SETTING OF UNITS.....	12
6.5 OUTPUT SELECTION 4-20 mA or 20-4 mA.....	12
6.6 DAMPING ADJUSTMENT .....	13
6.7 LANGUAGE .....	13
6.8 DEVICE SETUP .....	13
6.9 READOUT .....	14
6.10 CURRENT SIMULATION (4-20 mA) .....	15
6.11 TANK LINEARIZATION .....	15
6.12 BURST MODE .....	23
6.13 INFORMATION .....	24
6.14 FACTORY.....	24
6.15 FACTORY.....	24
<b>7. PROGRAMMING THE SERIES 4000 .....</b>	<b>25</b>
7.1 PROGRAMMING via HART .....	25
7.2 ROTABLE DISPLAY .....	26
<b>8. SPECIFICATIONS .....</b>	<b>27</b>
<b>9. PRECAUTIONS AND WARNINGS .....</b>	<b>28</b>
<b>Attachment: EU-Declaration of Conformity.....</b>	<b>29</b>

## 1. INTRODUCTION

The SERIES 4000 and SERIES 4000-SAN are solid-state pressure- and level transmitters based upon a piezoresistive silicon sensor, with a very high burst pressure. The sensor element is mounted in a stainless steel foot. Inside the foot also a temperature sensor is mounted to measure the process temperature. The temperature sensor is used to create an active temperature compensation. A strong stainless steel "flush" diaphragm protects the sensor from the process medium. A very small amount of special oil fills the chamber surrounding the sensor and transfers pressure from the flush mounted diaphragm to the sensor.

Pressure on the sensor element creates a very small deflection of the silicon substrate and bridge network. The resulting strain in the silicon resistors causes a change in the bridge resistance that is proportional to the pressure applied. The transmitter electronics detects this change in bridge resistance and converts it into 4-20 mA. The amplifier system is based on a single Integrated Circuit, which ensures a perfect linearity in the 4-20 mA output, all within an accuracy of 0.075 %. Due to the **Klay flush diaphragm technology** the long term stability is perfect.

### 1.1 DESCRIPTION SERIES 4000-SAN

The SERIES 4000-SAN are specially designed with a flush mounted diaphragm so they fully meet the needs of the food, pharma and chemical industries. Standard the wetted parts are made of SS 316 L, other materials are available, like Hastelloy C. Various process connections can be delivered, such as Tri-Clamp (1,5", 2" and 3"), SMS (1,5" and 2"), dairy milk couplings (DN 25, 40 and 50), flanges (DIN and ANSI) and sanitary weld-on nipples (ø 48, 62 and 85 mm.)

### 1.2 DESCRIPTION SERIES 4000

The SERIES 4000 are specially designed for the pulp- and paper or similar industries, where clogging is a problem. The very compact construction of the SERIES 4000 permits flush installation with the tank- or pipe wall. Standard the wetted parts are made of SS 316, a lot of other materials like Hastelloy C and Gold plated are available as an option.

All transmitters are **fully temperature compensated**, which means that various process temperatures have nearly no effect on the accuracy of the output signal. When a failure occurs, the transmitter is repairable. However, for optimum accuracy the transmitter has to be send back to the factory.

### 1.3 BAROMETRIC REFERENCE

The series 4000 (SAN) is in basic a so-called "relative transmitter" which means that barometric changes will not affect the zero (4 mA). The venting is placed in the cover of the electronics housing and is the filter for the barometric reference to atmospheric pressure. The venting must be kept clean.

## 2. DIMENSIONAL DRAWINGS

### Series 4000-SAN

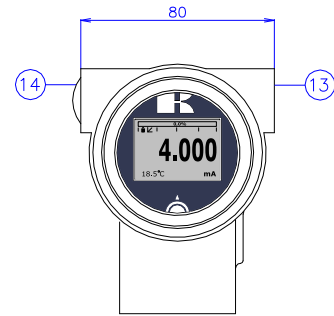
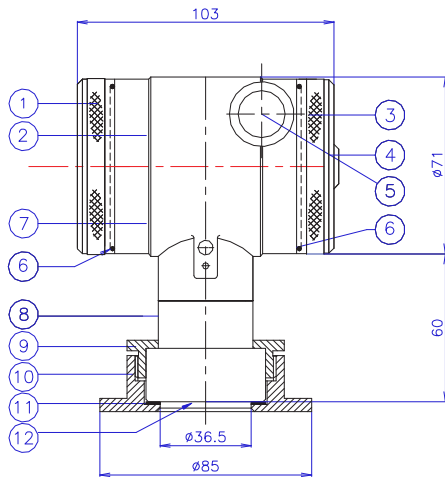

Front view: Transparent cover, option "I" (extra price)

Description	Material
① Cover	SS 304
② Display with navigation button	
③ Cover with venting	SS 304
④ Venting	PA
⑤ M20 x 1,5 cable entry (without gland) *	
⑥ O-Ring	EPDM
⑦ Electronics housing	SS 304

Description	Material
⑧ Foot	SS 316
⑨ Lock ring	SS 304
⑩ Weld-on nipple	SS 316 L
⑪ Gasket	PTFE
⑫ Diaphragm	SS 316 L
⑬ M20 x 1.5 cable entry (without gland) *	
⑭ M20 x 1.5 cable entry (Blanking plug)	PE

### Series 4000 - 1" BSP

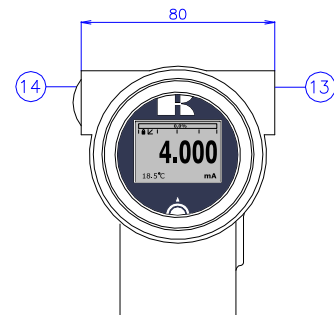
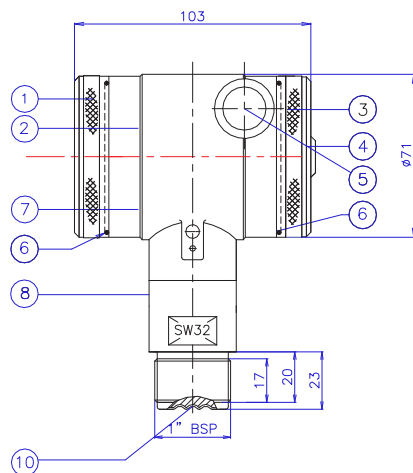

Front view: Transparent cover, option "I" (extra price)

Description	Material
① Cover	SS 304
② Display with navigation button	
③ Cover with venting	SS 304
④ Venting	PA
⑤ M20 x 1,5 cable entry (without gland) *	
⑥ O-Ring	EPDM
⑦ Electronics housing	SS 304

Description	Material
⑧ Foot	SS 316
⑨ Lock ring	SS 304
⑩ Diaphragm	SS 316 L
⑬ M20 x 1.5 cable entry (without gland) *	
⑭ M20 x 1.5 cable entry (Blanking plug)	PE

\* As standard the Series 4000 will be supplied with **two** cable entries M20 x 1,5. A cable gland can be supplied by request (extra costs).

### 3. INSTALLING THE TRANSMITTER

The diaphragm of the transmitter is protected with a special protection cap. Protect the diaphragm until installation takes place. **Do not damage the diaphragm.**

#### 3.1 INSTALLING WELD-ON NIPPLE

A certified welder should perform the installation of the weld-on nipple. Weld with Argon, MIG or TIG, with the smallest welding pin possible.

1. Cut a hole in the process vessel or pipe for a precise fit of the weld-on nipple. The hole should be a tight fit when coupled with the weld-on nipple.
2. Prepare the hole by bevelling the edge to accept filler material.
3. Remove the weld-on nipple from the transmitter.

**Remove the gasket and O-Ring out of the weld-on nipple!**

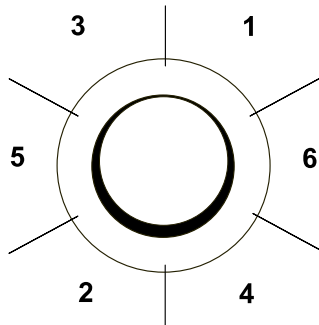

#### WARNING

**Improper installation may result in distortion of the weld-on nipple. Excessive heat will distort the weld-on nipple. Weld in sections as shown in the figure left. Allow adequate cooling between passes. To reduce the chances of distortion to the weld-on nipple, use a mandrel.**

(SERIES 4000-SAN: Part.no. 1019 – Art.no. 10230)

Lockring Part.no. 1160 – Art.no. 10001

(SERIES 4000: Part.no. 1016 – Art.no. 10282)

Determine (before welding) the position of the electronics housing, so that the cable entry and the venting are in the right position. After welding these positions are fixed.

4. Position the weld-on nipple in the vessel hole and tack six places. The weld sequence is shown in the figure above.
5. Weld the weld-on nipple in place using 0,03 to 0,045 in. (0,762 to 1,143 mm) stainless rod as filler material in the bevelled area. Adjust amperage for penetration.
6. Remove the mandrel after the welding operation.

#### 3.2 INSTALLING TRANSMITTER SERIES 4000-SAN (Code W)

1. Make sure to correctly locate the packing within the weld-on nipple.
2. Improper installation of the packing can cause a process leak.
3. Position the transmitter into the weld-on nipple and begin engaging threads.
4. The transmitter can be rotated prior to seating enabling the user to optimize access to calibration adjustments, cable entry, and local indicator.
5. Once the Lock ring has been hand tightened, it must be tightened with an additional turn ( $\pm 1/8''$ ) with adjustable pliers.

#### 3.3 INSTALLING TRANSMITTER SERIES 4000 (Code W33)

1. After welding, clean up edges, and take care of the inside nipple wall.
2. Make sure the O-rings ⑩ and ⑪ are properly located.
3. Improper installation of the O-ring can cause a process leak.
4. Apply silicone grease to the O-ring ⑩, diaphragm ring and the hole inside wall of the weld-on nipple, this prevents galvanic cell corrosion between transmitter and the nipple inside.
5. Install the transmitter and fix it with the SS M8 bolt.

### 3.4 MOUNTING POSITION

When the transmitter is mounted horizontally, the cable gland must be pointed downwards.

### 3.5 MOUNTING POSITION EFFECT

All transmitters are calibrated in vertical position (diaphragm points downwards).

If the transmitter is mounted in another position, there can be a little zero shift. (example 4,02 mA instead of 4,00 mA). After installation of the transmitter the zero must be set to 4,00 mA with **P103** (cancel mounting position effect). This will not affect the span.

### 3.6 CALIBRATION

All transmitters are fully calibrated at the factory, to customer specified range. If the calibration is not specified, the transmitter will be calibrated at the maximum span.

### 3.7 WIRING

Under the cover ③ you will find the terminal board.

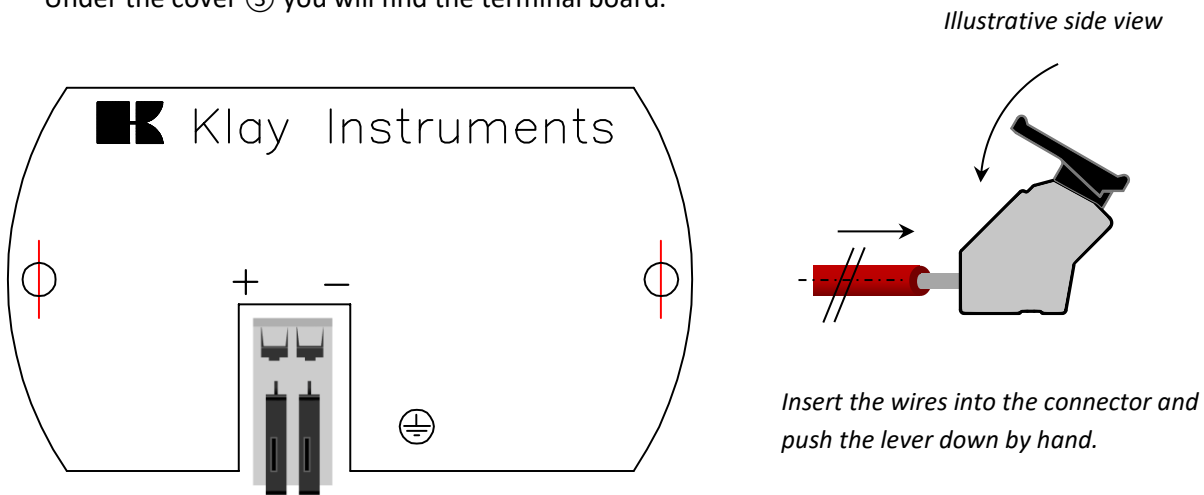

The figure above shows the wiring connection of the transmitter. The 2-wires must be connected to + and - on the terminal board. The wiring terminals can be operated without a screwdriver. The opening levers of the terminals can be lifted and pressed down by hand. Lift the opening levers of the terminals and insert the corresponding wires. Press down the levers by hand, the terminal spring will close and the wire is clamped. *Optionally a secondary 4-20 mA output is available on request.*

The transmitter must be connected with standard two-wire shielded cable. Do not run signal wiring in open trays with power wiring, or near heavy electrical equipment (e.g. Frequency controllers or heavy pumps). Shielding must always be connected at the side of the power supply. In case the process connection is already connected to ground (e.g. via the tank or pipe line) do **not** connect the instrument to ground. In applications with synthetic process connections, the enclosure (internal or external) must be connected to ground.

Reversing the polarity will not damage the transmitter, but the transmitter will not function until the + and - are properly connected.



**Please ensure that the transmitter is not connected to ground twice to prevent an earth loop.**

## 4. REMAINING

### 4.1 EXTERNAL LOAD

External loads must be placed in the negative side of the 2-wire loop. The minimum power supply is based on the total circuit resistance. The maximum external load (R<sub>I</sub> max.) for 24 Vdc will be 600 Ω (Ohm). At higher power supply, the external load can be up to max. 1200 Ω / 36 Vdc.

**⚠ With a loop resistance of 250 Ω a power supply of at least 17 Vdc must be used.**

$$R_I \text{ max.} = \frac{\text{Voltage} - 12 \text{ V (min. voltage)}}{20 \text{ mA}}$$

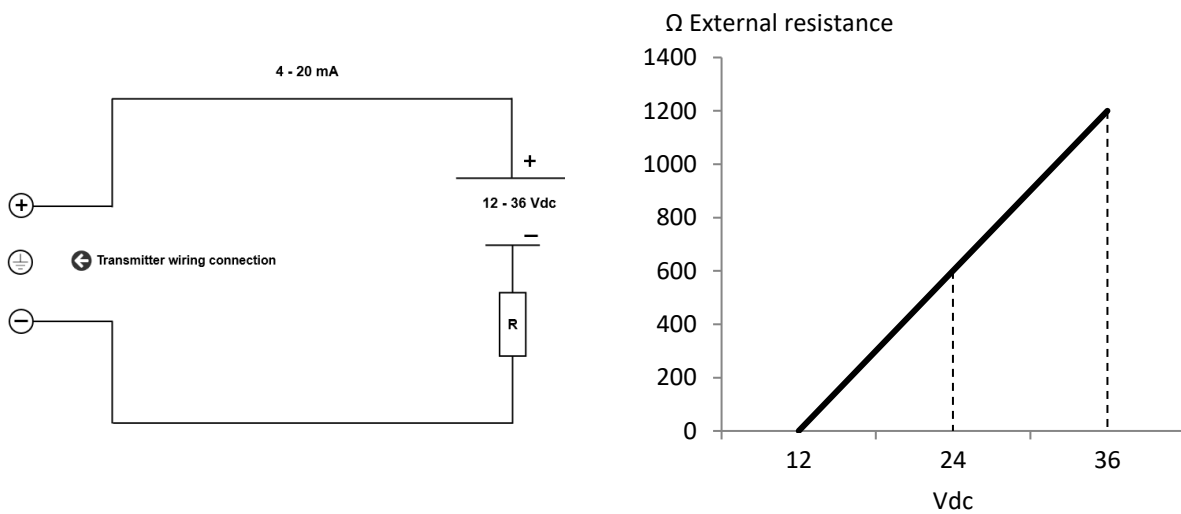

### 4.2 CE / EMC-RULES

All Klay transmitters are manufactured in accordance with the RFI / EMC directives and comply with the CE standard. All transmitters are fitted with RFI filters, which provide optimum, trouble-free operation. Our products are in conformity with EMC-Directive 2014/30/EU based on test results using harmonized standards.

### 4.3 TRACEABILITY / YEAR OF MANUFACTURING

The year of manufacturing of the transmitter can be traced as follows: take the first three numbers from the serial number that is engraved in the transmitter and add 1600 to it. Example: Serial Number 41602123. The year of manufacturing is 1600 + 416 = 2016.

#### 4.4 INTRINSICALLY SAFE (Option Ex)

The Series 4000 and 4000-SAN are also available for intrinsically safe for use in zone 0.



**ATEX** – KIWA 15ATEX0031 X  
 II 1G Ex ia IIC T5...T4 Ga (-20 < T<sub>amb</sub> < 70°C)  
 II 1G Ex ia IIC T6 Ga (-20 < T<sub>amb</sub> < 31°C)



**IECEx** – KIWA 15.0014X  
 Ex ia IIC T5...T4 Ga (-20 < T<sub>amb</sub> < 70°C)  
 Ex ia IIC T6 Ga (-20 < T<sub>amb</sub> < 31°C)

For detailed explanation see “EU-Declaration of conformity” on the last page of this manual.

For use in an **Intrinsically Safe** area, use a certified power supply from 12 - 30 Vdc. Installation of this device must be carried out by a certified mechanic or installer.

Transmitter type and options	Equipment category	Temperature Class	Ambient temperature range
Pressure / Level Transmitter Series 4000 and Series 4000-SAN With closed covers	II 1G	T5 ... T4	-20 °C to +70 °C  Process temperature range: -20 °C to +100 °C
Pressure / Level Transmitter Series 4000 and Series 4000-SAN With transparent indicator cover (Option I)	II 1G	T5 ... T4	-20 °C to +70 °C  Process temperature range: -20 °C to +100 °C
Pressure / Level Transmitter Series 4000 and Series 4000-SAN With closed covers	II 1G	T6	-20 °C to +31 °C  Process temperature range: -20 °C to +50 °C
Pressure / Level Transmitter Series 4000 and Series 4000-SAN With transparent indicator cover (Option I)	II 1G	T6	-20 °C to +31 °C  Process temperature range: -20 °C to +50 °C
Option, Electrical variant	Temperature Class	Ambient Temperature	Process Temperature
Single 4-20 mA output G190, with dual 4-20 mA Output	T4	-20° C to + 70° C	-20° C to + 100° C
G185, with single 4-20 mA output	T5	-20° C to + 70° C	-20° C to + 100° C
	T6	-20° C to + 31° C	-20° C to + 50° C

#### Electrical Data

Pressure / Level Transmitter Series 4000 and Series 4000-SAN

Supply/output circuit (terminals + and -): in type of protection intrinsic safety Ex ia IIC only for connection to a certified intrinsically safe circuit, only with a supply range from 12 till 30 Vdc, with the following maximum values: **U<sub>i</sub>** = 30 Vdc; **I<sub>i</sub>** = 110 mA; **P<sub>i</sub>** = 0,9 W; **L<sub>i</sub>** = 0,08 mH; **C<sub>i</sub>** = 41 nF (without cable between terminals + and -)

Pressure / Level Transmitter Series 4000 and Series 4000-SAN (**Option G190**).

Supply/output circuit (terminals + and -) and a **2<sup>nd</sup>** Supply/output circuit (terminals + and -): in type of protection intrinsic safety Ex ia IIC only for connection to a certified intrinsically safe circuit only with a supply range from 12 till 30 Vdc, separate for each output, with the following maximum values:

**U<sub>i</sub>** = 30 Vdc; **I<sub>i</sub>** = 110 mA; **P<sub>i</sub>** = 0,9 W; **L<sub>i</sub>** = 0,08 mH; **C<sub>i</sub>** = 41 nF (without cable between terminals + and -)

*The maximum values are applicable for each output. The maximum connected power for each output is 0,9 W, not available for T5 and T6.*

#### Instructions

The instructions provided with the equipment shall be followed in detail to assure safe operation.

#### Special conditions for Safe use in Zone 0

- As standard the transmitter is supplied **without** a certified cable gland. The cable entry is fitted with a PE blanking plug for protection during transport. Remove the blanking plug after installing the transmitter. When using a gland make sure it is certified and complying with applicable protection level of the transmitter.
- Always use the covers supplied by Klay Instruments B.V.
- From safety point of view, the transmitter must be connected to ground.

*All certifications are in compliance with ATEX and IECEx scheme rules, and the International Standards: EN IEC 60079-0: 2018, EN 60079-11: 2012, IEC 60079-0:2017 and IEC 60079-11:2011. The transmitters are certified for use in hazardous areas by KIWA Nederland B.V.*



**DO NOT REMOVE OR UNSCREW THE COVER(S) WHEN AN EXPLOSIVE ATMOSPHERE MAY BE PRESENT.**



## 5. GRAPHIC DISPLAY AND NAVIGATION BUTTON

The 4000 series has a multifunctional display where different values can be displayed simultaneously. The display is equipped with a backlight. The entire menu is controlled by a navigation button. The navigation button has the following possibilities of movement: up, down, left, and right. The navigation button needs to be pushed when conformation or saving is needed.

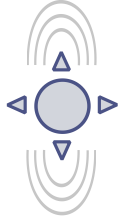

Move the navigation button up or down to browse through various menus. These movements can be distinct in choices of: program points, navigation through menu's and increase or decrease measurement value's.

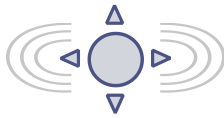

Move the navigation button left or right to navigate horizontally through the menu or positions on the display.

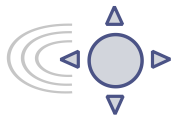

**It is always possible to return to the previous menu.** Move the navigation button to the left to return to the previous menu.

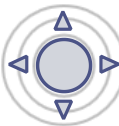

By pushing the navigation button each choice will be **confirmed** or a setting will be **saved**.

Figure 1. Display Series 4000, fully rotatable (360°)



### 5.1 GRAPHIC DISPLAY READOUT

When the transmitter is powered, a flash screen with the name of the transmitter (Series 4000) and the software version appears for a few seconds. After this the home screen will show the measured value setting as set in the factory.

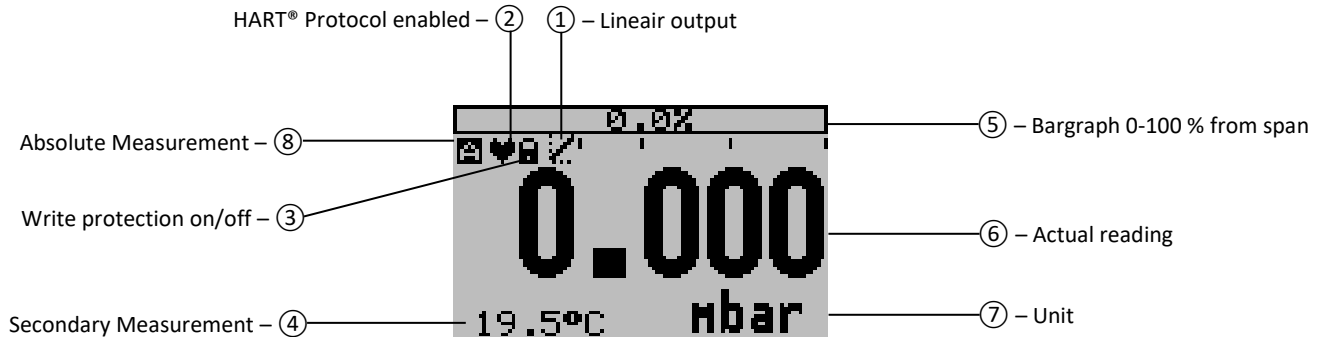

#### EXPLANATION OF SYMBOLS:

1. – **Linear output:** Displays when any form of linearization is applied. a Straight line means no linearization is applied. When a linearization is applied a curve will be displayed.
2. – **HART® protocol:** Displays a HART symbol, when HART protocol option is available.
3. – **Write protection on/off:** Displays if protection against adjustments and configuration is on or off
4. – **Secondary Measurement:** Displays a secondary chosen measurement.
5. – **Bargraph 0-100 % from span:** Displays the percentage of the measured span.
6. – **Measurement:** Displays the current measurement in mA, percentage or a selectable unit.
7. – **Unit:** Displays the selected unit.
8. – **Absolute:** Appears when the measurement is in absolute range.

### 5.2 SUMMARY PROGRAMMING POINTS

PROGRAM POINT	NAME	FUNCTION
P100	Menu-Exit menu	Start and exit
P101	ZERO value	Zero adjustment (ZERO 4 mA) with or without test pressure
P102	SPAN value	Span adjustment (SPAN 20 mA) with or without test pressure
P103	MOUNT correction	Cancel mounting position effect (4 mA)
P104	UNITS	Selection of engineering unit to be displayed
P105	REVERSE mA	Output selection 4-20 mA or 20-4 mA
P106	DAMPING	Adjustable damping (0,00 till 25,00 s)
P107	LANGUAGE	Language choice between: English, Dutch, German, Russian, Polish and French.
P108	DEVICE SETUP	Configuration of: Protection, Alarm, Backlight, Temperature, Secondary value, (Set time and HART Version, only when HART protocol is present.)
P109	READOUT	Readout options on display: Current, unit, percentage and temperature
P110	CURRENT SIMULATION	Current simulation 4-20 mA (Stepwise or free adjustable)
P111	TANK LINEARIZATION	Configuration for tank linearization
P112	BURST MODE	Configuration for burst mode (Only when HART protocol is present.)
P113	INFORMATION	Contact information of Klay Instruments, made settings, and software revision
P114	FACTORY	Only available for the manufacturer
P115	FACTORY	Only available for the manufacturer

## 6. EXPLANATION PROGRAMMING POINTS

### **P101** Zero value

#### 6.1 ZERO ADJUSTMENT (ZERO, 4 mA)

The transmitter is set to 0 mbar at atmospheric pressure.

The **ZERO** can be adjusted at a lower or higher point. This will be explained step by step by an example.

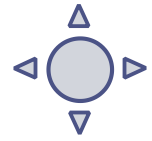

Example: Increase ZERO till 100 mBar.

1. The measuring unit of the transmitter is set to mBar. If not this can be selected by choosing the right measuring unit in program point **P104 – UNITS (paragraph 6.4)**
2. Navigate to program point **P101 - ZERO Value**, and push the navigation button to enter the menu.
3. Two choices appear on the screen: “**set manual**” and “**use process**”  
**Set manual** = Configuration without test pressure.  
**Use process** = Configuration with applied pressure.
4. Choose “**set manual**”, +000.0 (mBar) will appear on the display.
5. Increase this value with the navigation button to 100 mBar, push to confirm, and select **SAVE** to save the setting.
6. The transmitter will return to the home screen. The measurement value at atmospheric pressure is now -100 mBar. At an applied pressure of 100 mbar the transmitter will display 0 mbar.

The menu zero adjustment also has the choice of “**use process**”. The transmitter can be adjusted to zero in a real process situation. When chosen, the transmitter will measure the pressure in an actual process. This measurement will be used as the zero value. (4 mA)

1. Navigate to program point **P101**, and push the button to enter the menu.
2. Choose “**use process**”, and push to confirm. The transmitter will display the actual measured value.
3. Push the navigation button to confirm, and select **SAVE** to save the setting.
4. The transmitter will return to the main menu.

### **P102** Span value

#### 6.2 SPAN ADJUSTMENT (SPAN, 20 mA)

This setting can be used to adjust the range (SPAN) an entered value or adjusted with or without an pressure. The maximum pressure which can be measured (20 mA) is the measurement at

**ZERO (P101) + the entered value SPAN (P102)**. If the **ZERO (P101)** is increased, then the maximum measured value will automatically be set higher at same rate like the zero.

This will be explained step by step by an example.

Example: Measurement range 0 – 2000 mbar = 4 - 20 mA.

The **span** must be set at 2000 mbar

1. Navigate to program point **P102 - SPAN Value**, and push the navigation button to enter the menu.
2. Two choices appear on the screen: **Set manual** and **Use process**  
Choose **Set manual**, a value will appear on the screen. (Depending on the range.)
3. Adjust the **SPAN** with the navigation button to 2000 mbar. and select **SAVE** to save the setting
4. The transmitter will return to the home screen.

The menu span adjustment also has the choice of “**use process**”. The transmitter can be adjusted to the span in a real process situation. When chosen, the transmitter will measure the pressure in an actual process. This measurement will be used as the span value. (20 mA)

1. Navigate to program point **P102**, and push the button to enter the menu.
2. Choose “**Use process**”, and push to confirm. The transmitter will display the actual measured value.
3. Push the navigation button to confirm, and select **SAVE** to save the setting.
4. The transmitter will return to the main menu.

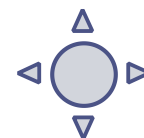

according to applied



P102 is the adjustment of the total span.

When a compound range must be adjusted (for example -1 till +3 bar), a span of 4 bar must be programmed. The Zero (P101) must be set at -1 bar. The transmitter is adjusted at **-1 bar = 4 mA** and **+3 bar = 20 mA**.

If the process temperature at -1 bar is above 20 °C another filling oil must be applied inside the transmitter (Option G26).  
If the process temperature at -0,5 bar is above 60 °C another filling oil must be applied inside the transmitter (Option G26).

**P103**  
Mount corr.

**6.3 CANCEL MOUNTING POSITION EFFECT (4 mA)**

All transmitters are vertically calibrated. If the transmitter is installed horizontally, the transmitter has a small "mounting position" effect on the zero (4 mA). The current value displayed, will be for example 4,020 mA instead of 4,000 mA. This effect can be neutralized within this menu.

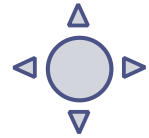

1. Navigate to program point **P103 – MOUNT corr.**, and push the navigation button to enter the menu.
2. Two choices appear on the screen: **“Set”** and **“Reset”**

Choosing **Set** will adjust the zero to 4,000 mA in the mounting position when applicable.

- Select **Set**, and push the button to confirm.
- The Save  icon will be displayed to indicate that the setting is saved.
- The transmitter will return to the main menu.

Choosing **Reset** will put the transmitter back to factory setting. (vertical adjustment 4 mA)

- Select **Reset**, and push the button to confirm, the setting will be put back to factory setting. The Save  icon will be displayed to indicate that the setting is saved.
- The transmitter will return to the main menu.



**Do not apply pressure while executing "Cancel mounting position effect"**

For low pressure ranges, the mounting effect on the zero point will be more noticeable, therefore it is important to execute P103 after installing the transmitter.

**P104**  
Units

**6.4 DISPLAY SETTING OF UNITS**

Various engineering units can be displayed on the display.

Factory setting = mbar

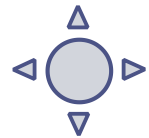

1. Navigate to program point **P104 – UNIT**, and push the navigation button to enter the menu.
2. Several engineering units can be selected. Each selected engineering unit is automatically converted to the correct value of the corresponding unit.
3. Navigate through this menu and choose the required unit, push to confirm.
4. The Save  icon will be displayed to indicate that the setting is saved.
5. The transmitter will return to the main menu, the measured reading will be displayed in the chosen unit in the home screen.



**CAUTION:** The selected pressure unit is only visible on the display, if **UNITS** is chosen in program point **P109 – Readout**.

**P105**  
Reverse mA

**6.5 OUTPUT SELECTION 4-20 mA or 20-4 mA**

The transmitter is standard set to 4-20 mA.

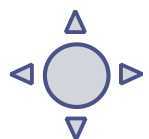

1. Navigate to program point **P105 – Reverse mA**, and push the navigation button to enter the menu.
2. Two choices appear on the screen: **4-20 mA** and **20-4 mA**
3. Make an output choice and push to confirm.



4. The Save  icon will be displayed to indicate that the setting is saved.
5. The transmitter will return to the main menu.

## P106 Damping

### 6.6 DAMPING ADJUSTMENT

The transmitter has an adjustable damping between 0,00 to 25,00 seconds. Factory setting = 0,00 seconds

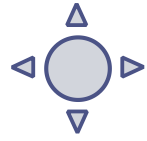

1. Navigate to program point **P106 – DAMPING**, and push the navigation button to enter the menu.
2. Two choices appear on the screen: **Set** and **Reset**
3. Make a choice and push to confirm.

Choosing **Set** allows a value to be set between 0,00 and 25,00 seconds.

- Select **Set**, and push the button to confirm.
- Adjust the damping with the navigation button, push to confirm.
- The Save  icon will be displayed to indicate that the setting is saved.
- The transmitter will return to the main menu.

Choosing **Reset** will put the setting back to factory setting (0,0 seconds)

- Select **Reset**, and push the button to confirm.
- The Save  icon will be displayed to indicate that the setting is saved, the setting will be put back to factory setting 0,00 s.
- The transmitter will return to the main menu.

## P107 Languages

### 6.7 LANGUAGE

In this menu the preferred menu language can be selected.

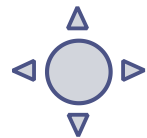

1. Navigate to program point **P107 - LANGUAGE**, and push the navigation button to enter the menu.
2. Five choices appear on the screen: **English, Dutch, Spanish, German, Russian, Polish** and **French**.
3. Make a choice and push to confirm.
4. The Save  icon will be displayed to indicate that the setting is saved.
5. The transmitter will return to the main menu.

## P108 Device setup

### 6.8 DEVICE SETUP

In this menu, several operational settings can be made for the transmitter and the display.

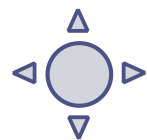

1. Navigate to program point **P108 – Device Setup**, and push the navigation button to enter the menu.
2. Eight choices appear on the screen: **Protection - Alarm output - Backlight - Temp units – Temp min/max – Sec. Value - Set Time** and **HART® Version** (*Set time and HART® version are only available when HART® protocol is present in the transmitter*)
3. Choose the desired option, push to confirm.
4. Below are the choices displayed. They can be selected and configured using the navigation button.
  - **Protection:**
    - **Local:** The local protection for adjusting settings locally on the transmitter.
    - **External:** The external security for adjusting settings remotely on the transmitter by HART® protocol.
  - **Alarm output:**
    - **Low:** The lower limit of the lowest permissible current value. (3,2 mA)
    - **High:** The upper limit of the maximum permissible current value (22,8 mA)

When exceeding the above limits, a warning symbol will display on the screen.

- **Backlight:** Choice between: **On**, **Sleep mode** (Turn off backlight after 5 minutes) and **Off**. The intensity of the backlight is depending on the output current.
- **Temp units:** Choice between: **Celsius** and **Fahrenheit**.
- **Temp min/max:** Two choices appear on the screen: **Readout** and **Reset**  
By choosing **Readout** the last measured minimum and maximum temperature values of process and ambient appear. For the process temperature, a new value is stored in a change of temperature more than 2 ° C. For the ambient temperature this is 5 ° C. By choosing **Reset** the previous stored values will be deleted.
- **Sec. Value:** Four choices appear on the screen for the secondary readout on the main screen: **Current**, **Unit**, **Rate** and **Temperature**.
- **Set Time:** (Only available when using HART® 7 Protocol)  
An input screen to enter the date and time will appear.
- **HART® version:** Choice between: **HART® 5.0** and **HART® 7.0**.



## P109 Readout

### 6.9 READOUT

In this menu, the readout on the display is determined. This is the type of measurement that appears on the home screen.

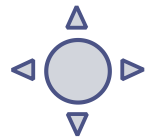
Factory Setting = Unit



1. Navigate to program point **P109 – READOUT**, and push the navigation button to enter the menu.
2. Nine choices appear on the screen:
  - Current** = Present current value (4-20mA)
  - Unit** = Pressure unit as chosen in **P104**
  - Percentage** = 0-100%
  - Temperature** = Actual sensor temperature (°C or F) \*
  - Hectoliter** = Number of hectoliters (only possible in combination with linearization P111)
  - Cubic meter** = Number of cubic meters (only possible in combination with linearization P111)
  - Liter** = Number of liters (only possible in combination with linearization P111)
  - Kilogram** = Number of kilograms (only possible in combination with linearization P111) After selecting this readout the **Specific Gravity** of the medium (**SG** = g/cm<sup>3</sup>) must be entered with a value between 0.2 and 4.0 g/cm<sup>3</sup>. The specific gravity will appear on the home screen (g/cm<sup>3</sup>) under the primary chosen readout. This readout will be indicated as a linear measurement, and displayed by the symbol  on the home screen.
  - Tons** = Number of tons (only possible in combination with linearization P111) After selecting this readout, the **Specific Gravity** of the medium (**SG** = g/cm<sup>3</sup>) must be entered with a value between 0.2 and 4.0 g/cm<sup>3</sup>. This readout will be indicated as a linear measurement, and displayed by the symbol  on the home screen. The specific gravity will appear on the home screen (g/cm<sup>3</sup>) under the primary chosen readout.
3. Navigate to the desired choice, confirm the selection by pushing the navigation button. The Save  icon will be displayed to indicate that the setting is saved.
4. The transmitter will return to the main menu.

\*(Indication of process temperature, accuracy depending on sensor position)



*For measuring weight (Kg and Tons), a reliable accuracy cannot be guaranteed, the Series 4000 pressure transmitter cannot compensate for Specific Gravity changes or any thermal increase or decrease.*

**P110**  
 Curr sim.

**6.10 CURRENT SIMULATION (4-20 mA)**

The transmitter can simulate an output between 4-20 mA. Using five predefined steps or a free selectable value between 3,80 mA to 20,8 mA (Transmitters with HART® Protocol 3,90 mA to 20,8 mA)

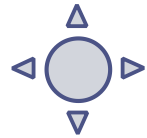

1. Navigate to program point **P110 – CURR SIMU**, and push the navigation button to enter the menu.
2. Two choices appear on the screen: “**Set**” and “**Free**”
3. Choosing **Set** allows a value to be set in five steps: 4, 8, 12, 16, 20 mA
  - By default, the current simulation is **Not active**, as shown in the display
  - Choose one of the five steps, and push to confirm
  - The status on the display will change to **Active** and the current simulation is started for the selected step.
  - Push the navigation button to de-activate the current simulation.
  - Move the navigation button to the left to go back and leave this menu.
4. With the option **Free**, a current between 4 and 20 mA can be configured.
  - By default, the current simulation is **Not active**, as shown in the display.
  - Enter the desired value, and push to confirm.
  - The status on the display will change to **Active** and the current simulation is started for the selected value.
  - Push the navigation button to de-activate the current simulation.
  - Move the navigation button to the left to go back and leave this menu.

**P111**  
 Tank lin.

**6.11 TANK LINEARIZATION**

In this menu, various tank linearization's can be selected.

Factory setting = No linearization

For a horizontal tank or a tank with a cone, linearization can be configured. The volume as a measured value will be displayed on the home screen. (Must be set in **P104**)  
 The values (configured in the following settings) must be in meters.

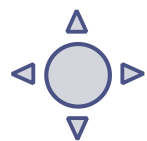

1. Navigate to program point **P111 – TANK LIN**, and push the navigation button to enter the menu. Six choices appear on the screen:
  - No Lin** = No linearization
  - Hor. Tank** = Linearization setting for a horizontal tank: cylindrical and elliptic
  - Vert. Cone** = Linearization setting for a vertical tank with a conical bottom.
  - Vert. Sphere** = Linearization setting for a vertical tank with a spherical bottom.
  - Vert. Trunc** = Linearization setting for a vertical tank with a truncated bottom.
  - Free lin** = Free linearization setting, adjustable in 70 free programmable points.

The following describes the setting for each linearization configuration.

**LINEARIZATION DISABLE**

With the choice **No. Lin.** an existing linearization can be turned off and can be identified by the symbol on the home screen: 

Linearization can be recognized by the following symbol on the home screen: 

1. Select **No Lin.** and confirm this with the button.
2. The Save  icon will be displayed to indicate that the setting is saved.

The following pages describe the setting for each type of linearization.

**LINEARIZATION HORIZONTAL TANK (WITH FLAT END)**

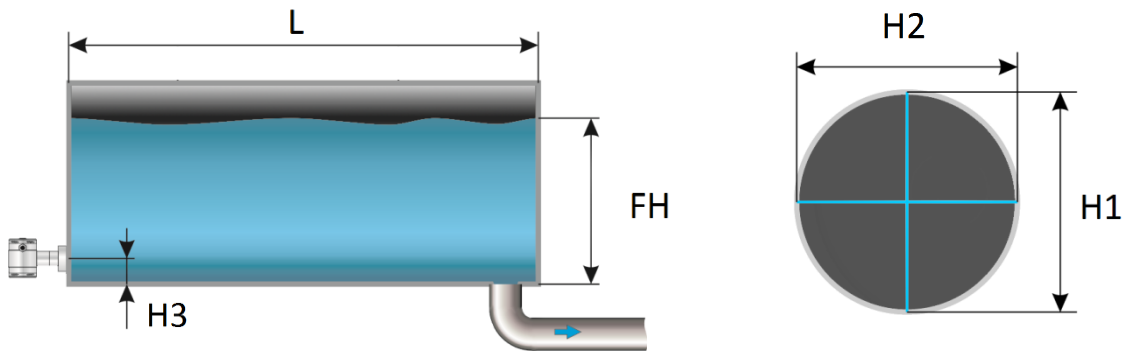

1. Navigate to **Hor. Tank.** with the navigation button, and push to confirm.
2. Two choices appear on the screen: **Input** and **Simulate**
3. Select **Input**, and push to confirm.
4. Six choices appear on the screen:

Display	Drawing	Explanation
Length	L	The length of the tank
Height 1	H1	The height of the tank
Height 2	H2	The diameter of the tank (with a cylindrical tank, this is equal to the height of the tank)
Height 3	H3	The height till the topside of the diaphragm (or weld-on nipple)
Height 4	H4	Value must be 0
Fill Height	FH	The maximum percentage of filling of the tank

5. Fill in each value except Height 4, and confirm each selection with the control button. The values must be entered in meters.
6. Select **SAVE** to save the setting.
7. The transmitter will return to the main menu.

**SIMULATION**

After linearization is entered and stored, it is possible to perform a simulation based on the entered value's. Based on the value entered in mWc, the transmitter will display the number of hectoliters (on the basis of the specified linearization values).

1. Navigate to program point **P111 – TANK LIN**, and push the navigation button to enter the menu.
2. Navigate to **Hor. Tank.** with the navigation button, and push to confirm.
3. Two choices appear on the screen: **Input** and **Simulate**
4. Select **Simulate**, and push to confirm.
5. Fill in the desired value based on mWc, the number of hectoliters change directly with a change in the value mWc.



**LINEARIZATION HORIZONTAL TANK WITH A PARABOLIC END (CYLINDRICAL OR ELLIPTIC)**

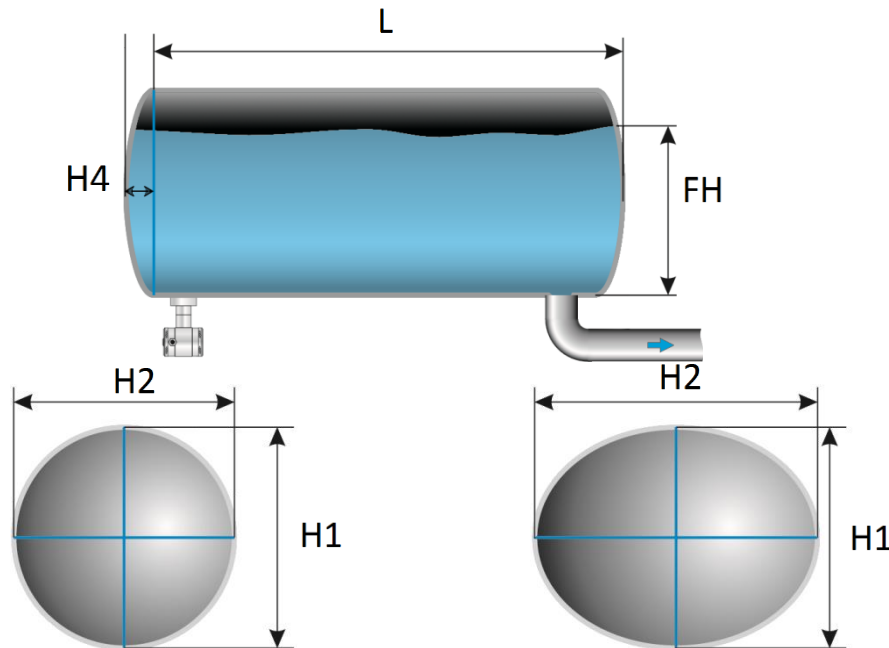

1. Navigate to **Hor. Tank.** with the navigation button, and push to confirm.
2. Two choices appear on the screen: **Input** and **Simulate**
3. Select **Input**, and push to confirm.
4. Six choices appear on the screen:

Display	Drawing	Explanation
Length	<b>L</b>	The length of the tank
Height 1	<b>H1</b>	The height of the tank
Height 2	<b>H2</b>	The diameter of the tank (with a cylindrical tank, this is equal to the height of the tank)
Height 3	<b>H3</b>	The height till the topline of the diaphragm (or weld-on nipple)
Height 4	<b>H4</b>	The length of 1 parabolic end of the cylinder
Fill Height	<b>FH</b>	The maximum percentage of filling of the tank

5. Fill in each value, and confirm with the navigation button. **The entered value's must be in meters.**
6. Select **SAVE** to save the setting.
7. The transmitter will return to the main menu.

**SIMULATION**

After linearization is entered and stored, it is possible to perform a simulation based on the entered value's. Based on the value entered in mWc, the transmitter will display the number of hectoliters (on the basis of the specified linearization values).

1. Navigate to program point **P111 – TANK LIN**, and push the navigation button to enter the menu.
2. Navigate to **Hor. Tank.** with the navigation button, and push to confirm.
3. Two choices appear on the screen: **Input** and **Simulate**
4. Select **Simulate**, and push to confirm.
5. Fill in the desired value based on mWc, the number of hectoliters change directly with a change in the value mWc.

**LINEARIZATION VERTICAL TANK WITH A CONICAL BOTTOM**

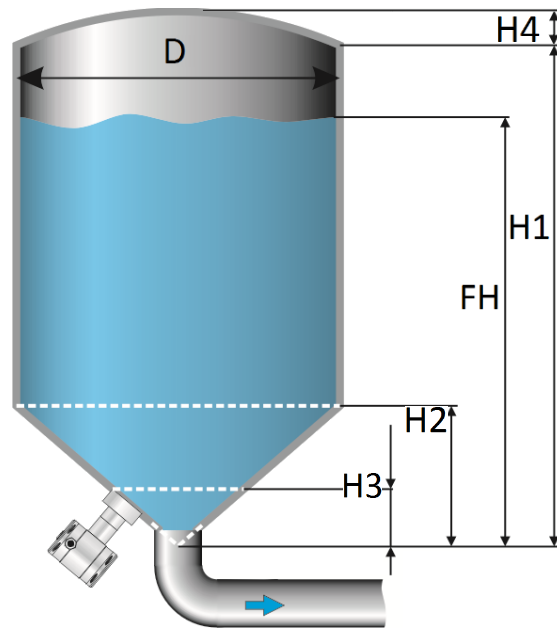

1. Navigate to **Vert. Sphere.** with the navigation button, and push to confirm.
2. Two choices appear on the screen: **Input** and **Simulate**
3. Select **Input**, and push to confirm.
4. Six choices appear on the screen:

Display	Drawing	Explanation
Height1	H1	The height of the tank
Diameter	D	The diameter of the tank
Height 2	H2	the height of the cone
Height 3	H3	The height till the topside of the diaphragm
Height 4	H4	The height of the parabolic tank roof
Fill Height	FH	The maximum percentage of filling of the tank

5. Fill in each value, and confirm with the navigation button. **The entered value's must be in meters.**
6. Select **SAVE** to save the setting.
7. The transmitter will return to the main menu.

**SIMULATION**

After linearization is entered and stored, it is possible to perform a simulation based on the entered value's. Based on the value entered in mWc, the transmitter will display the number of hectoliters (on the basis of the specified linearization values).

1. Navigate to program point **P111 – TANK LIN**, and push the navigation button to enter the menu.
2. Navigate to **Vert. Sphere.** with the navigation button, and push to confirm.
3. Two choices appear on the screen: **Input** and **Simulate**
4. Select **Simulate**, and push to confirm.
5. Fill in the desired value based on mWc, the number of hectoliters change directly with a change in the value mWc.

**LINEARIZATION VERTICAL TANK WITH A SPHERICAL BOTTOM**

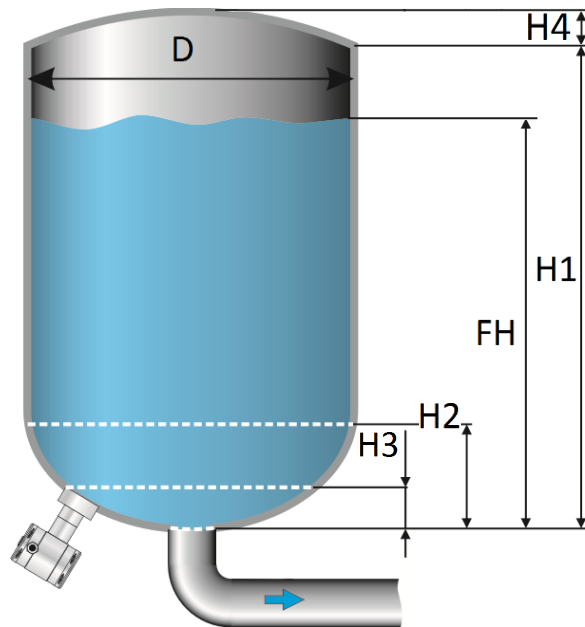

**Vert. Cone.** with the

1. Navigate to navigation button, and push to confirm.
2. Two choices appear on the screen: **Input** and **Simulate**
3. Select **Input**, and push to confirm.
4. Six choices appear on the screen:

Display	Drawing	Explanation
Height1	H1	The height of the tank
Diameter	D	The diameter of the tank
Height 2	H2	the height of the spherical bottom
Height 3	H3	The height till the topside of the diaphragm
Height 4	H4	The height of the parabolic tank roof
Fill Height	FH	The maximum percentage of filling of the tank

5. Fill in each value, and confirm with the navigation button. **The entered value's must be in meters.**
6. Select **SAVE** to save the setting.
7. The transmitter will return to the main menu.

**SIMULATION**

After linearization is entered and stored, it is possible to perform a simulation based on the entered value's. Based on the value entered in mWc, the transmitter will display the number of hectoliters (on the basis of the specified linearization values).

1. Navigate to program point **P111 – TANK LIN**, and push the navigation button to enter the menu.
2. Navigate to **Vert. Cone.** with the navigation button, and push to confirm.
3. Two choices appear on the screen: **Input** and **Simulate**
4. Select **Simulate**, and push to confirm.
5. Fill in the desired value based on mWc, the number of hectoliters change directly with a change in the value mWc.

**LINEARIZATION VERTICAL TANK WITH A TRUNCATED BOTTOM**

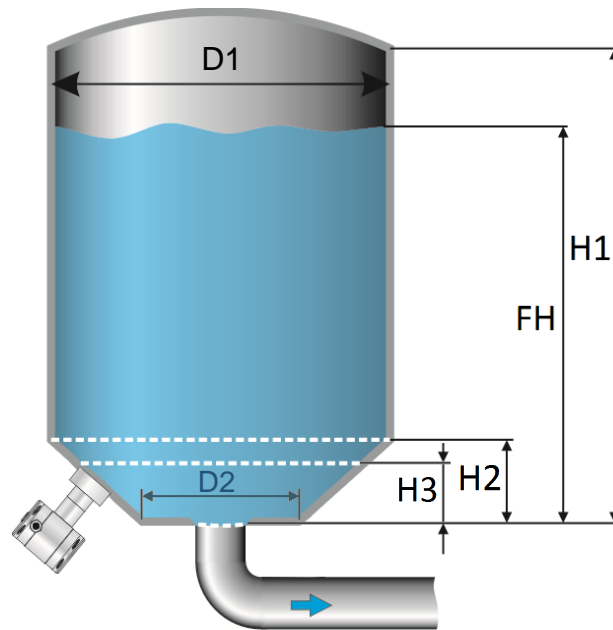

1. Navigate to **Vert. Trunc.** with the navigation button, and push to confirm.
2. Two choices appear on the screen: **Input** and **Simulate**
3. Select **Input**, and push to confirm.
4. Six choices appear on the screen:

Display	Drawing	Explanation
Height1	H1	The height of the tank
Diameter 1	D1	The diameter of the tank
Height 2	H2	the height of the cone
Height 3	H3	The height till the topside of the diaphragm
*Diameter 2	D2	The diameter of the truncated bottom
Fill Height	FH	The maximum percentage of filling of the tank

5. Fill in each value, and confirm with the navigation button. **The entered value's must be in meters.**
6. Select **SAVE** to save the setting.
7. The transmitter will return to the main menu

\*It's also possible that Height 4 (H4) is visible on the screen. There is nothing wrong. Diameter D2 is the same value as Height H4. You can fill in the same value.

**SIMULATION**

After linearization is entered and stored, it is possible to perform a simulation based on the entered value's. Based on the value entered in mWc, the transmitter will display the number of hectoliters (on the basis of the specified linearization values).

1. Navigate to program point **P111 – TANK LIN**, and push the navigation button to enter the menu.
2. Navigate to **Vert. Trunc.** with the navigation button, and push to confirm.
3. Two choices appear on the screen: **Input** and **Simulate**
4. Select **Simulate**, and push to confirm.
5. Fill in the desired value based on mWc, the number of hectoliters change directly with a change in the value mWc.

## FREE LINEARIZATION

### FREE LINEARIZATION IN PROCESS

1. Navigate to program point **P111 – TANK LIN**, and push to confirm.
2. Navigate to **Free lin.** with the navigation button, and push to confirm.
3. Two choices appear on the screen: **Measured** and **Manual**
4. Select **Measured** to configure a free linearization in a process situation.
5. Two choices appear on the screen: **Input** and **Simulate**
6. Select **Input**, and push to confirm
7. Five choices appear on the screen:

**Clear table:** The previous entered values for linearization will be deleted. It is advisable to use this feature for each time a new linearization is configured.



**All entered values and dimensions of an existing / previous linearization will be erased.**

**Volume units:** Select the preferred unit: Liters, Hectoliters, Kg and Tons (after linearization the unit can be changed and selected in **P109**)

**Height:** The height of the tank can be filled in (highly recommended for an accurate linearization). The transmitter will determine with this height the span. A linearization will be made with the smallest possible deviation. *Factory setting = Saved span in P102.*

**Start Point:** The filling of a tank can be measured up to 70 points. The transmitter must be installed in an actual process to accomplish these measurements. The measuring must take place from low to high. (Filling an empty tank). The actual measuring will be displayed on the screen in percentage (%) for **Xn** (filling) and for **Yn** the measured volume. To enter the next measured point, move the navigation button up and enter the values.

**Save:** When all desired measurements are completed and all parameters have been set, the linearization must be saved. Push the navigate button to the left and select **SAVE** to save the linearization. The transmitter will return to the main menu.



### WARNING AND PRECAUTIONS

- When a tank filling (**Xn**) does not reach 100 % of the height of the tank, the transmitter will calculate the remaining part. This calculating method is linear and will only be used for the remaining part up to 100 %.



- It is not advisable to manually adjust the SPAN in program point P102 after a linearization has been configured. If the SPAN is adjusted after a linearization configuration, a warning will appear on the screen when entering P102.
- When a free linearization is used for measuring weight (Kg and Tons), a reliable accuracy cannot be guaranteed due to external influences such as heat and tank wall expansion. **The change of Specific Gravity due to different temperatures cannot be compensated by the Series 4000 pressure transmitter.**

## SIMULATION

After linearization is entered and saved, it is possible to perform a simulation. (Based on the saved linearization) The transmitter will convert the entered mWc to hectoliters.

### FREE LINEARIZATION MANUALLY

When it's not possible to enter and measure for a linearization in an actual process condition, a free linearization can be configured manually. Known measurements values and volumes must be entered manually in the transmitter.

1. Navigate to program point **P111 – TANK LIN**, and push the navigation button to enter the menu.
2. Navigate to **Free lin.** with the navigation button, and push to confirm.
3. Two choices appear on the screen: **Measured** and **Manual**
4. Select **Manual** to configure a free linearization manually.
5. Two choices appear on the screen: **Input** and **Simulate**
6. Select **Input**, and push to confirm.
7. Five choices appear on the screen:

**Clear table:** The previous entered values for linearization will be deleted. It is advisable to use this feature for each time a new linearization is configured.



**All entered values and dimensions of an existing / previous linearization will be erased.**

**Volume units:** Select the preferred unit: Liters, Hectoliters, Kg and Tons (after linearization the unit can be changed and selected in **P109**).

**Height:** The height of the tank can be filled in (highly recommended for an accurate linearization). The transmitter will determine with this height the span. A linearization will be made with the smallest possible deviation. *Factory setting = Saved span in P102.*

**Start Point:** The contents of a tank can be configured up to 70 points. The entered value's must be from low to high (Filling an empty tank). The manually entered values will be displayed on the screen in percentage (%) for **Xn** and for **Yn** in Hectoliters. To enter the next measured point, move the navigation button up and enter the values.

**Example:** A tank filling must programmed in the transmitter.

- Choose **Clear Table** to remove all possible previous settings.
- Choose the preferred **Volume units**.
- Fill in the **Height** of the tank (highly recommended for an accurate linearization).
- In menu **Start Point** the linearization points can be filled in. In **Xn1** the percentage of the filling must be filled in. In **Yn1** the corresponding volume. After this, there are 69 more linearization points available.
- When all (needed) points are filled in, the linearization must be saved. Push the navigation button to the left and select **SAVE** to save this linearization.

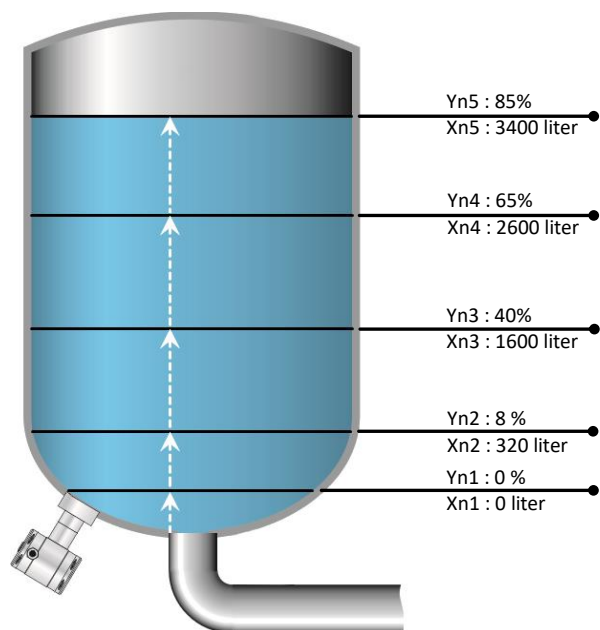

The figure above shows a tank with standard dimensions. Free linearization can applied on a wide variety of tanks with non-standard dimensions.

**Save:** When all desired measurements are completed and all parameters have been set, the linearization must be saved. Push the navigation button to the left to Exit and select **SAVE** to save the linearization. The transmitter will return to the main menu.

 **WARNING AND PRECAUTIONS**

- When a tank filling (Xn) is not configured till 100 %, the transmitter will calculate the remaining part. This calculating method is linear and will only be used for the remaining part up to 100 %.



- It is not advisable to manually adjust the SPAN in program point P102 after a linearization has been configured. If the SPAN is adjusted after a linearization configuration, a warning will appear on the screen when entering P102.
- When the a free linearization is used for measuring weight (Kg and Tons), a reliable accuracy cannot be guaranteed due to external influences such as heat and tank wall expansion. **The change of Specific Gravity due to different temperatures cannot be compensated by the Series 4000 pressure transmitter.**

**SIMULATION**

After linearization is entered and stored, it is possible to perform a simulation. (Based on the stored linearization) The transmitter will convert the entered mWc to hectoliters.

-  **As an option the Series 4000 and 4000-SAN can be delivered with option G171. This is a special setting of the software, enabling the display to show a reading in weight.**

**P112**  
**Burst mode**

**6.12 BURST MODE**

The transmitter (Only when HART® is present) can be configured for Burst mode. This will enable continuously broadcasting standard HART® reply messages.

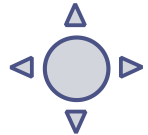

1. Navigate to program point **P115 – Burst Mode** and push the navigation button to enter the menu.
2. A message appears on the screen, push to enter this menu.
3. Three choices appear on the screen: “0”, “1” and “2”
4. With these choices, three distinct types of burst messages can be configured. Make a choice, and push the button to confirm.
5. Four choices appear on the screen: **Mode Cntrl**, **Cmd number**, **Period** and **Trigger** with these choices the chosen burst message (0,1 and 2) can be configured. Select **Mode Cntrl**, and push to confirm.
6. Two choices appear on the screen: “On” and “Off”
  - Choose **On** to turn on burst mode.
  - Choose **Off** to turn off burst mode.
7. Select Cmd number, and push to confirm.  
Five choices appear on the screen:
  - **Cmd 01** = PRIMARY VARIABLE
  - **Cmd 02** = CURRENT AND PERCENT OF RANGE
  - **Cmd 03** = DYNAMIC VARIABLES AND CURRENT
  - **Cmd 09** = DEVICE VARIABLES WITH STATUS
  - **Cmd 48** = ADDITIONAL TRANSMITTER STATUS

Choose the preferable burst mode, and push to confirm.

8. Select **Period**, and push to confirm.

Two choices appear on the screen: “**Max Time**” and “**Min Time**”

- Select **Max Time** to set the maximum amount of time when the message will be send. This value can be set from 0.5 to 3600 seconds.
- Select **Min Time** to set the minimum amount of time when the message will be send. This value can be set from 0.5 to 3600 seconds.

Enter the preferred value, and push to confirm.

9. Select **Trigger**, and push to confirm.

10. Five choices appear on the screen:

- |                   |   |  |
|-------------------|---|--|
| <b>Continuous</b> | = | The Burst message is send continuously.  |
| <b>Windowed</b>   | = | The Burst message is triggered when the measured value deviates more than the specified trigger value. |
| <b>Rising</b>     | = | The Burst message is triggered when the measured value rises above the triggered value.                |
| <b>Falling</b>    | = | The Burst message is triggered when the measured value falls below the triggered value.                |
| <b>On-Change</b>  | = | The Burst message is triggered when any value in the measuring changing.                               |

Choose the desired burst mode, and set the preferred parameters.

**P113**  
Information

**6.13 INFORMATION**

This menu shows a collection of information from the transmitter and contact information from the manufacturer.

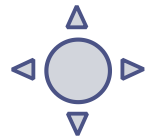

1. Navigate to program point **P113 - Information** and push the navigation button to enter the menu.
2. Push the navigation button up and down to see all of the information
3. Push the button to leave this menu.

Below is a representation of this information screen:

```

Klay Instruments
www.klay.nl
+31521591550
Version          -      Software revision
No:              -      Serial number transmitter
Zero            -      Zero (Bar)
Span            -      Span (Bar)
Damping         -      Damping (in seconds)
Output          -      Output 4-20 or 20-4 mA
Local Prot     -      Protection On or Off
Alarm          -      Alarm output (3.2 or 22.8 mA)
Sec. Value     -      Selected secondary configuration
Backlight      -      Backlight On, Sleep mode or Off
Temp           -      Temperature unit Celsius or Fahrenheit
HART® version  -      HART® version 5 or 7 (when HART® is present)
    
```

**P114**  
factory

**6.14 FACTORY**

Only available for the manufacturer.

**P115**  
factory

**6.15 FACTORY**

Only available for the manufacturer.



## 7. PROGRAMMING THE SERIES 4000

### 7.1 PROGRAMMING via HART:



When using HART® or a Hand Held Terminal (HHT), a minimum resistance of **250 Ω** must be present in the loop of the 2-wire system. This is necessary for proper communication (see drawing below). A power supply of at least **17 Vdc** must be used.

The Series 4000 can easily be programmed with the Hand Held Terminal (HHT) from the HART® Foundation (type 275 or 375 HART® Communicator).

**This is only possible if the option H (HART protocol) is chosen.**

*Option 1: HART® Handheld terminal connected across the transmitter.*

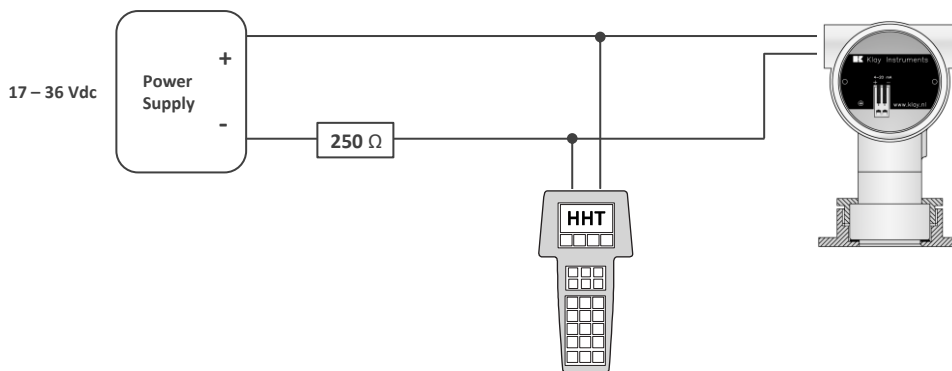

*Option 2: HART® Handheld terminal connected across the loop resistor.*

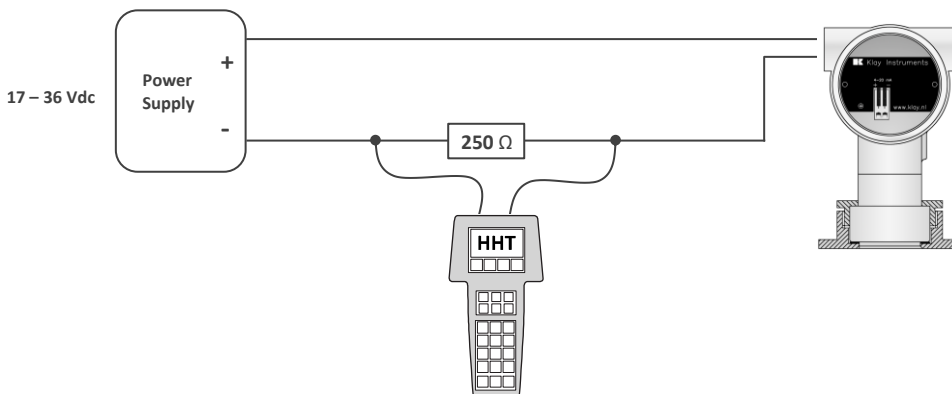

### PROGRAMMING by using DTM:

There is an instruction manual available which is a guide for installing and using the Klay Series 4000 HART DTM. This DTM is developed to make configuration changes of Klay Series 4000 HART transmitters easy. This DTM can be used with almost every FDT-container. The most recent version of the DTM file (zip file) is available on: [www.klay-instruments.com](http://www.klay-instruments.com) under section "Downloads", Software, Series 4000 zip files. Unzip and run the *DTM Klay\_ \_Series\_ 4000\_ HART\_ exe*.

## 7.2 ROTATABLE DISPLAY

The display from Series 4000 is fully rotatable. To rotate the display, place a small screw driver into the recess on top of the display. Turn it by hand by moving the screw driver into the desired direction, use the other hand to guide this movement to avoid any damages. The display can be turned both left and right.



## 8. SPECIFICATIONS

<b>Manufacturer</b>		Klay Instruments B.V.		
<b>Instrument</b>		Series 4000 and Series 4000-SAN		
<b>Output</b>		4-20 mA Option: HART® Protocol		
<b>Power Supply</b>		Standard : 12 – 36 Vdc Ex : 12 – 30 Vdc HART® : 17 – 36 Vdc (Standard) min. 250 Ω 17 – 30 Vdc (Ex) min. 250 Ω		
<b>Accuracy</b>		0,075% - (Turn down 10:1) 0,1% - (Turn down 10:1 ... 20:1)		
<b>Ranges <sup>1</sup></b>	Code	Adjustable span ranges		Max. overpressure
<b>Series 4000</b>	20	0-0,1 bar	0-1,2 bar	6,4 bar
	30	0-0,5 bar	0-10 bar	50 bar
	40	0-5 bar	0-100 bar	200 bar
<b>Series 4000-SAN</b>	20	0-0,05 bar	0-1,2 bar	10 bar
	30	0-0,5 bar	0-10 bar	50 bar
	40	0-5 bar	0-100 bar	200 bar
<b>Series 4000 <sup>2</sup></b>		High Pressure	Option G83	> 600 bar
<b>Process Temperature</b>				
Series 4000-SAN <sup>3</sup>	Standard	-20°C to +100°C (-4°F to 212°F)		
Series 4000	Standard	-20°C to +80°C (-4°F to 176°F) (Optional 100°C)		
Series 4000/4000-SAN	Ex - Temperature Class T5 ... T4	-20°C to +100°C (-4°F to 212°F)		
Series 4000/4000-SAN	Ex - Temperature Class T6	-20°C to +50°C (-4°F to 176°F)		
<b>Ambient Temperature</b>				
Series 4000/4000-SAN	Standard	-20°C to +70°C (-4°F to 158°F)		
Series 4000/4000-SAN	Ex - Temperature Class T5 ... T4	-20°C to +70°C (-4°F to 158°F)		
Series 4000/4000-SAN	Ex - Temperature Class T6	-20°C to +31°C (-4°F to 104°F)		
<b>Temperature effect</b>		0,015 %/K		
<b>Damping</b>		0,00 seconds to 25,00 seconds Standard: 0,00 seconds.		
<b>Protection Grade</b>		IP66		
<b>Material</b>		Housing "wetted" parts		
		AISI 304 (Optional AISI 316) AISI 316 L (Other materials on request)		

1: For vacuum applications and compound ranges in combination with higher process temperatures a special oil filling must be applied (Option G26).

2: For pressures higher than order code 40, contact Klay Instruments for information.

3: For higher temperatures use Klay option HT (High Temperature), contact Klay Instruments for information.

## 9. PRECAUTIONS AND WARNINGS

- Check if the specifications of the transmitter meet the needs of the process conditions
- When the Series 4000 (SAN) is used as a level transmitter, be aware of the place where the transmitter is mounted. Here are some suggestions:
  - DO NOT mount a level transmitter in- or near filling or discharging pipes.
  - In case of automatic cleaning systems or hand cleaning: never point the water jets on the diaphragm, take necessary steps to avoid this. Guarantee will not be granted.
- When the Series 4000 is used as a pressure transmitter, be aware of the following points:
  - Rapid closing valves in combination with high flow velocity will cause water hammer(spikes) and can destroy the transmitter. DO NOT mount a transmitter near such valves, always a few pipe bends away up or down stream (avoid suction).
  - Install a pressure transmitter a few pipe bends away from pumps, as well on the suction or pressure side of the pump
- **WELDING INFORMATION:**  
When using the Series 4000 or 4000-SAN code "W" the welding information on page 4 must be followed exactly. This is very important to prevent distortion of the weld-on nipples. It also prevents the screw thread from the Series 4000-SAN (M56 x 1,25) from being deformed.
- The diaphragm of the transmitter is protected with a special protection cap. Protect the diaphragm until installation takes place, to prevent damaging of the diaphragm.
- As soon as the wiring is brought inside through the cable gland and connected to the terminal board, make sure the cable gland is tightly fixed, so that moisture cannot enter into the electronics housing.
- Avoid high pressure water-jets pointed at the venting.
- If the ambient conditions are very wet, we advise to use a venting through the cable. A special vented cable can be connected on request. (The normal venting will be removed) In that case the transmitter is IP68.
- The covers ① and ③ must be fully engaged, so that moisture cannot ingress into the electronics housing.
- **WARRANTY:** The warranty is 1 year from delivery date.  
Klay Instruments B.V. does not accept liability for consequential damage of any kind due to use or misuse of the Series 4000. Warranty will be given, to be decided by the manufacturer. For evaluation and repair the transmitter must be shipped prepaid to the factory on manufacturers authorization.
- **NOTE:** Klay Instruments B.V. reserves the right to change its specifications at any time, without notice. Klay Instruments B.V. is not an expert in the customer's process (technical field) and therefore does not warrant the suitability of its product for the application selected by the customer.

**Manufactured by:** **KLAY-INSTRUMENTS B.V.**  
[www.klay.nl](http://www.klay.nl)Nijverheidsweg 5  
P.O. Box 13  
Tel: +31-521-591550  
Fax: +31 -521-5920467991 CZ DWINGELOO  
7990 AA DWINGELOO  
The Netherlands  
E-mail: [info@klay.nl](mailto:info@klay.nl)

Attachment: **EU-Declaration of Conformity.**

## EU-DECLARATION OF CONFORMITY



### Klay Instruments B.V.

Nijverheidsweg 5, 7991 CZ Dwingeloo, The Netherlands

Certify that the equipment intended for use in potentially explosive atmospheres, indicated here after:

Electronic Pressure / Level Transmitter Series 4000, Series 4000-SAN and Series 4000-VALVE  
 Differential Pressure Transmitter Series DP-4000  
 Temperature Transmitter TT-4000 and TT-4000-REMOTE

Are in accordance with:

- Directive 2014/34/EU (Equipment and protective systems intended for use in potentially explosive atmospheres)
- Directive 2014/30/EU (Electro Magnetic Compatibility).
- Harmonized standards:
  - EN 60079-0: 2018 (General rules)
  - EN 60079-11:2012 (Equipment protection by intrinsic safety "i")
  - EN 61326-1: 2013 (3,Electrical equipment for measurement, control and laboratory use– Part 1)
  - EN-ISO-IEC 80079-34:2018 (Potentially explosive atmospheres – Application of Quality Systems)
  - IEC 61000-6-2:2001 (EMC, Immunity in industrial location)
  - IEC 61000-6-3:2001 (EMC, Emission in industrial location)
  - IEC 61000-6-4:2001 (EMC, Emission in industrial location)
  - IEC 61298-3 (Test for the effects of influence quantities. Test 13.1 Common mode interference and 13.2 Normal mode interference (series mode)).
- The type (protection mode Intrinsic Safety “ia”) which has been the subject of; EC-type Examination, Certificate Number: KIWA 15ATEX0031 X, Issue 2  
 Delivered by Kiwa Nederland B.V. (Unit Kiwa ExVision), Wilmersdorf 50, 7327 AC Apeldoorn, The Netherlands, Notified body No. 0063

Manufacturing plant in Dwingeloo which has been the subject of;  
 Production Quality Assurance, Notification Number: DEKRA 12ATEXQ0041, Issue 4  
 Delivered by DEKRA Certification, Meander 1051, 6825 MJ Arnhem,  
 The Netherlands, Notified body No. 0344

Date: May 25th , 2021  
 E. Timmer  
 Managing Director – Klay Instruments B.V.

Signature:



The marking of the equipment for gas group for use in zone 0:

**II 1 G Ex ia IIC T4 Ga or  
 II 1 G Ex ia IIC T5 Ga and  
 II 1 G Ex ia IIC T6 Ga**

II	equipment for use in industries above ground (and not in mines endangered by firedamp).
1	equipment for use in Zone 0
G	equipment for use with gas, vapours or mists
Ex	equipment in compliance with European standards for explosive atmospheres
ia	equipment in compliance with specific building rules for intrinsically safe equipment

IIC	equipment for use with gas of subdivision C
T4	equipment whose surface temperature does not exceed 135°C when used in an ambient temperature < 70°C.
T5	equipment whose surface temperature does not exceed 100°C when used in an ambient temperature < 70°C.
T6	equipment whose surface temperature does not exceed 85°C when used in an ambient temperature < 31°C for the highest temperature class T6.

Ingress Protection Grade, Series 4000, 4000-SAN, 4000-VALVE, DP-4000, TT-4000 and TT-4000-REMOTE: **IP 66**

Furthermore, whatever the protection mode, only use cable glands with a protection degree of at least IP 66. Be sure the cable diameter complies with the selected cable gland. Tighten the cable gland in a proper way. Never forget to mount the covers of the electronics housings in a proper way.

**For other technical details, refer to the instruction manuals of the transmitters.**